

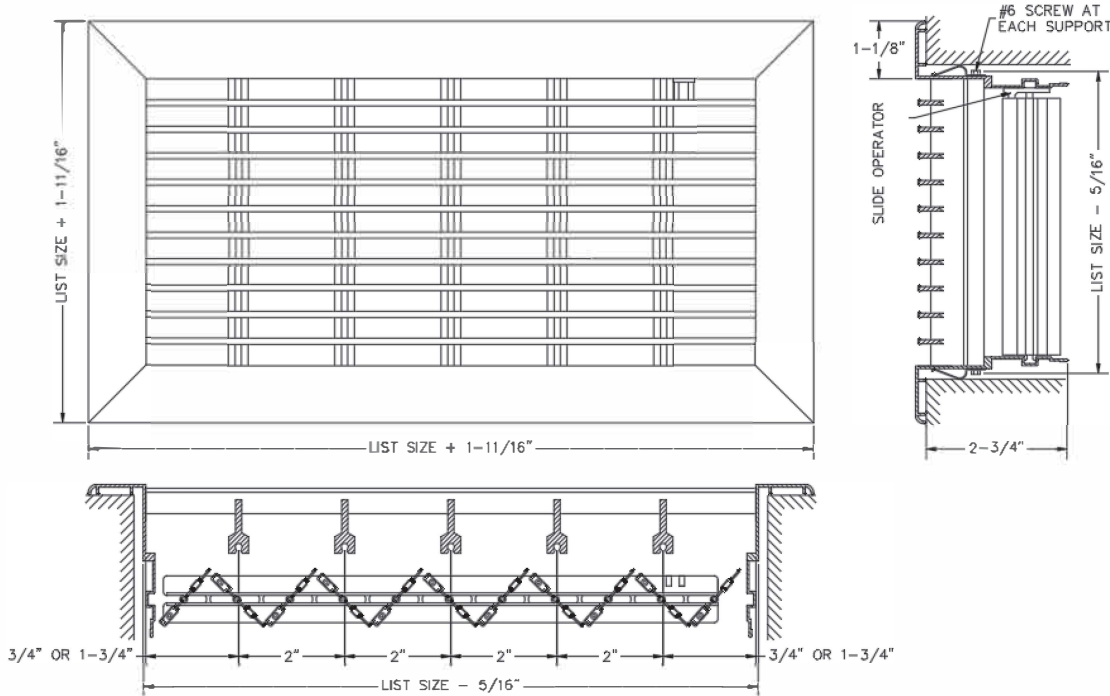

- Reinforced heavy duty core with supports every 2".
- Fully extruded, high quality aluminum construction for a stylish appearance.
- Opposed blade damper with slide operator.
- Fixed blades parallel to the long dimension.
- Designed for floor or reinforced sidewall, sill and ceiling installation.
- Available on 1/2" increments as standard. Custom sizes available down to 1/16" increments.
- Available with durable powder coat finish.



1. Select a Blade Option

- 00 - 0° Deflection
- 01 - 0° Pencil Proof
- 15 - 15° Deflection
- 30 - 30° Deflection
- 82 - 0° Air Flow
- 84 - 0° Heel Proof

2. Select a Mounting Option

- A - Screw Holes
- B - Spring Clips
- C - Concealed Brackets
- TB - No Mounting

Available for floor use in continuous lengths and up to 16" heights.

3 DAY SHIP
ANY SIZE. ANY MODEL.
GUARANTEED

3. Specify the Length x Height Dimensions

Inches MM _____ x _____

Additional Options
See specific submittal pages for options listed below.

- N - No Flange
- R - Removable Core

4. Select a Finish

- W - White
- S - Silver
- B - Brown
- M - Mill
- FB - Flat Black
- Special: _____

5. Select a Lead Time

- 3 Day Ship
- Next Friday
- Standard Delivery

Project / Location: _____

Architect: _____

Engineer: _____

Contractor: _____



BLADE OPTIONS

-00

0° 13/64" blades on 1/2" centers

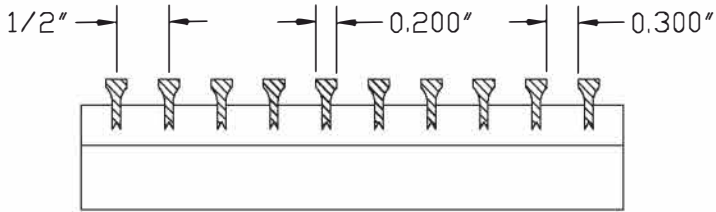

-01

0° 1/4" blades on 1/2" centers

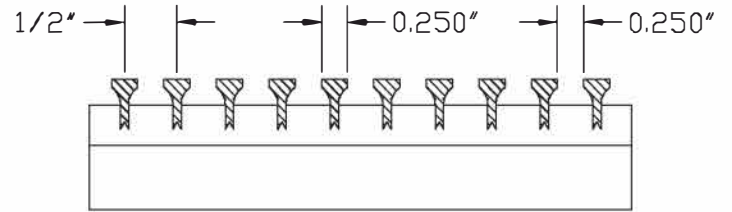

-15

15° 13/64" blades on 1/2" centers

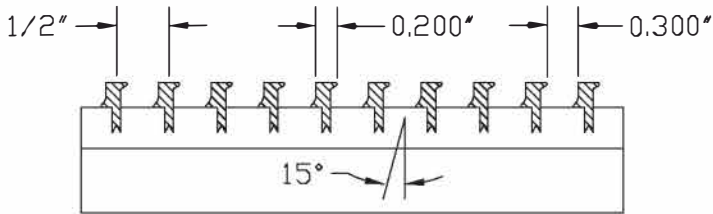

-30

30° 13/64" blades on 1/2" centers

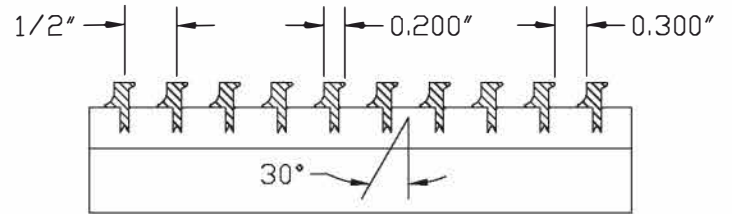

-82

0° 1/8" blades on 1/2" centers

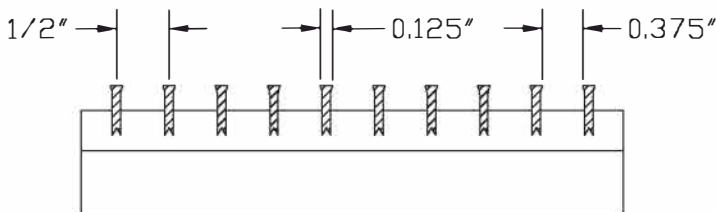

-84

0° 1/8" blades on 1/4" centers

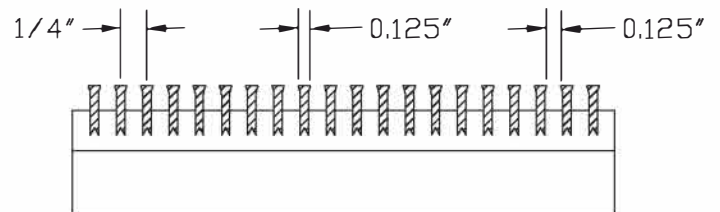

MOUNTING

-A
Screw Holes

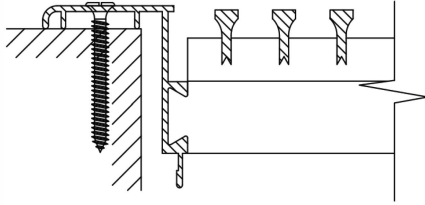

Color matched screws with countersunk screw holes.

-B
Spring Clips

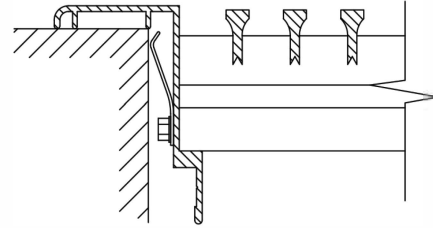

Hidden clips behind the flange to keep the grille secure in the opening. Only suitable for floor & sill applications.

-C
Concealed Brackets

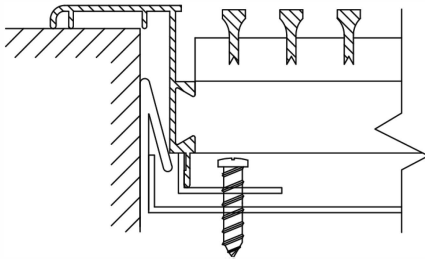

Product is fastened to duct-mounted brackets, which are concealed behind the blades.

-D
Sidewall Screw Holes

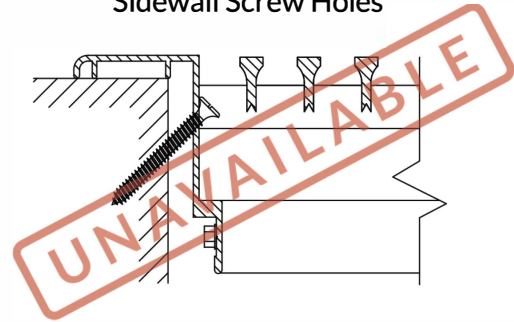

Screw holes are drilled at a 45° angle on inner flange. Only available with Removable Core.

-TB
No Mounting

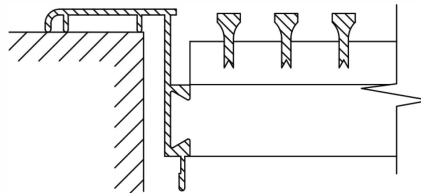

Designed for lay-in ceiling and custom applications. For lay-in, order 2" under to account for flange.

e.g. 22" x 10" will have O.D. 23-11/16" x 11-11/16" and fit a standard 24" x 12" T-bar opening.